



Name _____

Learn the Math

Use  and  to add. Write the sum. Break apart  to subtract. Write the difference.

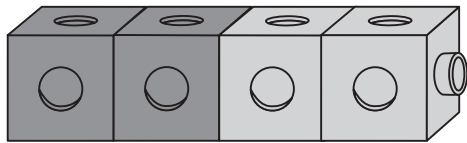

$$2 + 2 = \underline{\quad}$$

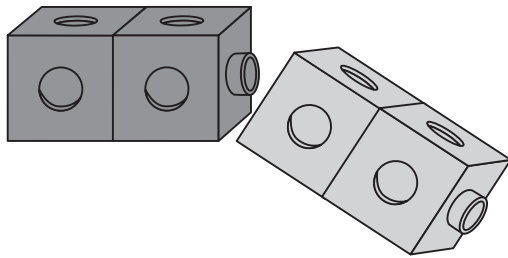

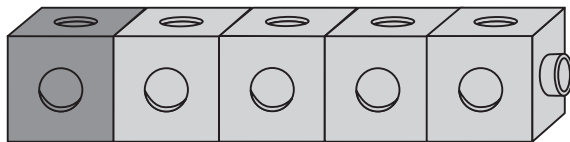

$$4 - 2 = \underline{\quad}$$

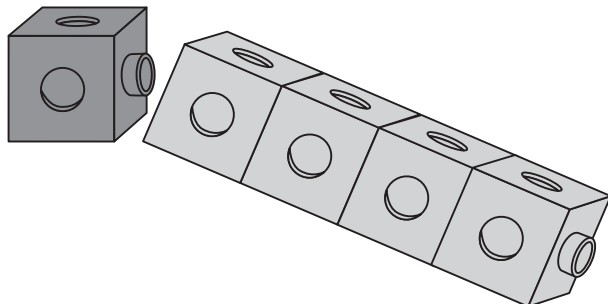

$$1 + 4 = \underline{\quad}$$



$$5 - 4 = \underline{\quad}$$

Use  and  to add. Write the sum.
 Break apart  to subtract.
 Write the difference.

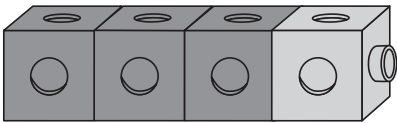

$$3 + 1 = \underline{\quad}$$

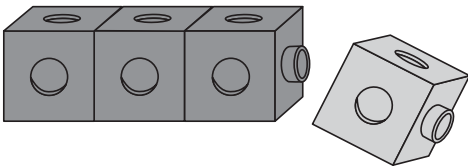

$$4 - 1 = \underline{\quad}$$

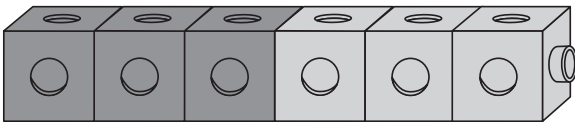

$$3 + 3 = \underline{\quad}$$

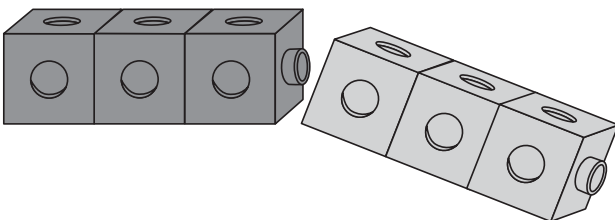

$$6 - 3 = \underline{\quad}$$